

# Arroma

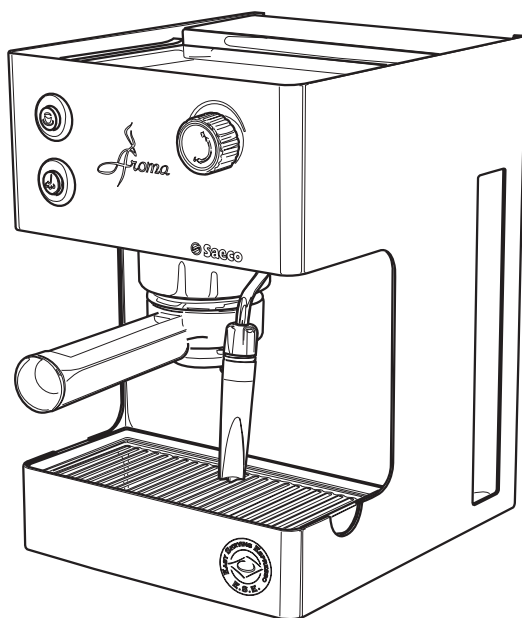

ISTRUZIONI PER L'USO  
OPERATING INSTRUCTIONS  
MODE D'EMPLOI  
BEDIENUNGSANLEITUNG  
INSTRUÇÕES PARA O USO  
INSTRUCCIONES PARA EL USO  
GEBRUIKSAANWIJZING  
INSTRUKCJE OBSŁUGI



LEGGERE ATTENTAMENTE QUESTE ISTRUZIONI D'USO PRIMA DI UTILIZZARE LA MACCHINA.  
READ THESE OPERATING INSTRUCTIONS CAREFULLY BEFORE USING THE MACHINE.  
LIRE ATTENTIVEMENT CES INSTRUCTIONS AVANT D'UTILISER LA MACHINE.  
DIESE BEDIENUNGSANLEITUNG IST VOR DEM ERSTEN GEBRAUCH DER MASCHINE AUFMERKSAM ZU LESEN.  
LER ATENTAMENTE ESTAS INSTRUÇÕES PARA O USO ANTES DE USAR A MÁQUINA.  
LÉANSE ATENTAMENTE LAS SIGUIENTES INSTRUCCIONES DE USO ANTES DE UTILIZAR LA MÁQUINA.  
LEES DEZE INSTRUCTIES AANDACHTIG DOOR VOORDAT U HET APPARAAT IN GEBRUIK NEEMT.  
PRZECZYTAĆ UWAGAŻNIE NINIEJSZE INSTRUKCJE OBSŁUGI PRZED UŻYTKOWANIEM URZĄDZENIA.

**FOR HOUSEHOLD USE ONLY  
USAGE DOMESTIQUE SEULEMENT**

**Ideas with Passion**

**Saeco**

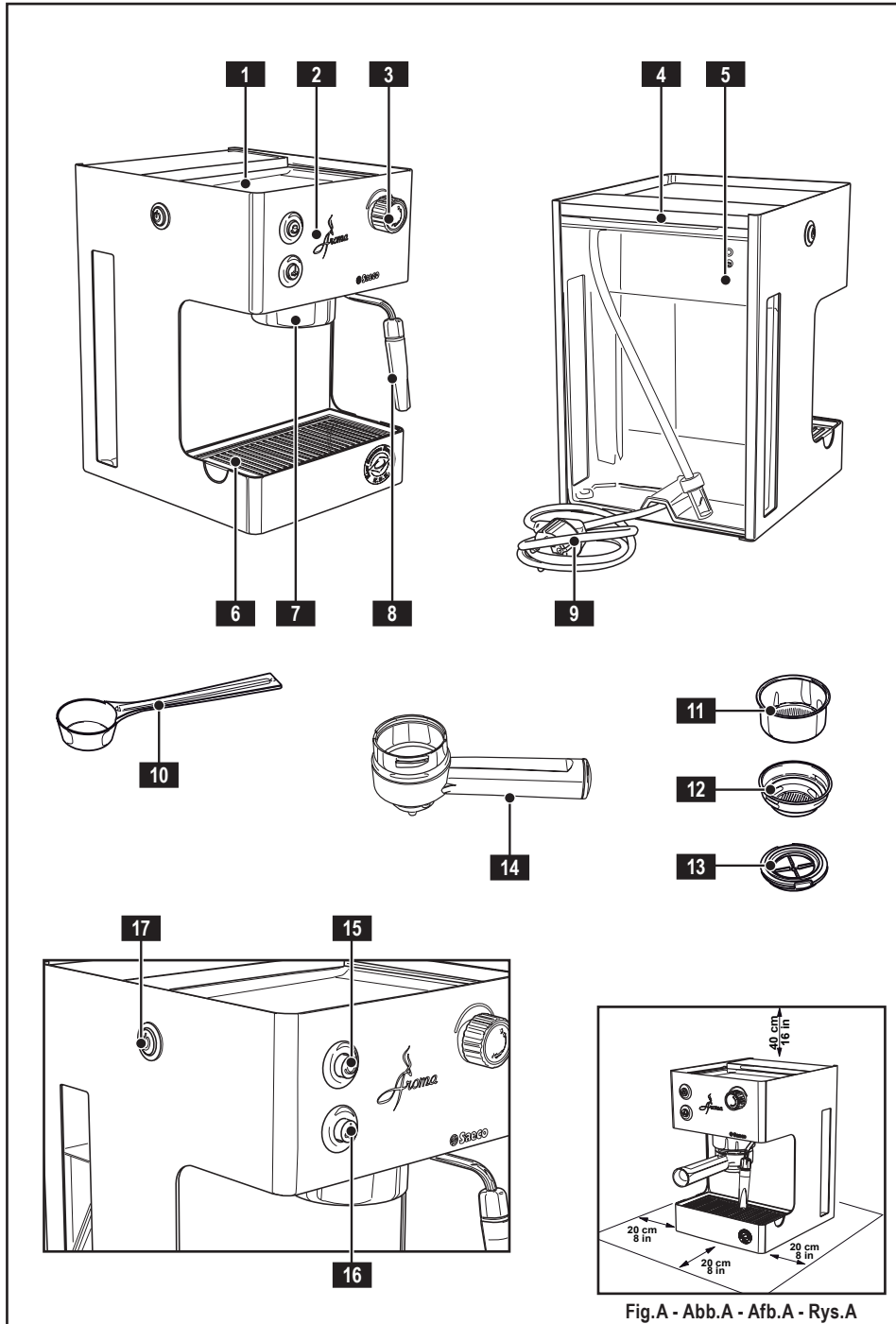

Fig.A - Abb.A - Afb.A - Rys.A

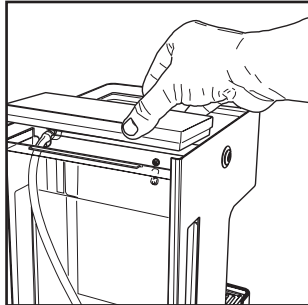

Fig.1 - Abb.1 - Afb.1 - Rys.1

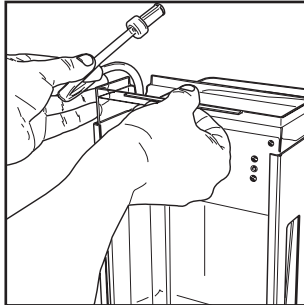

Fig.2 - Abb.2 - Afb.2 - Rys.2

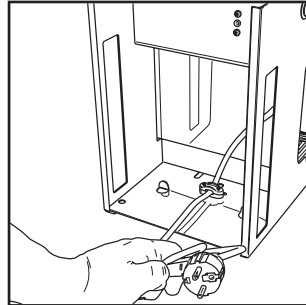

Fig.3 - Abb.3 - Afb.3 - Rys.3

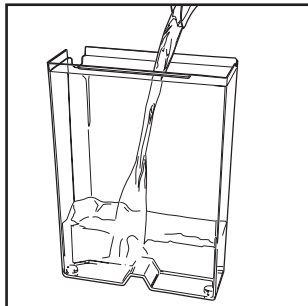

Fig.4 - Abb.4 - Afb.4 - Rys.4

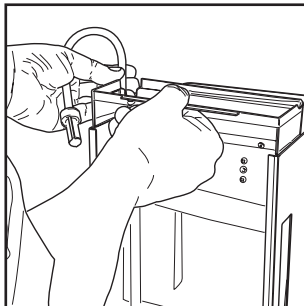

Fig.5 - Abb.5 - Afb.5 - Rys.5

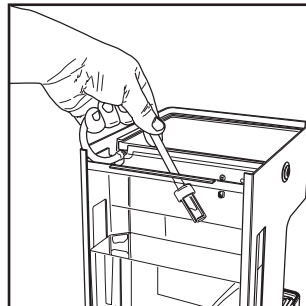

Fig.6 - Abb.6 - Afb.6 - Rys.6

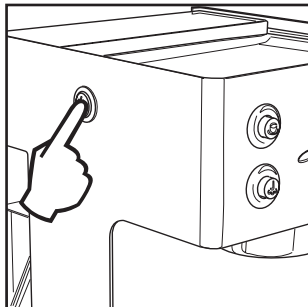

Fig.7 - Abb.7 - Afb.7 - Rys.7

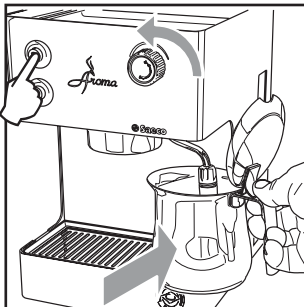

Fig.8 - Abb.8 - Afb.8 - Rys.8

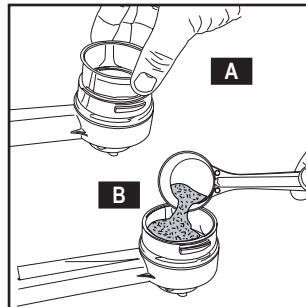

Fig.9 - Abb.9 - Afb.9 - Rys.9

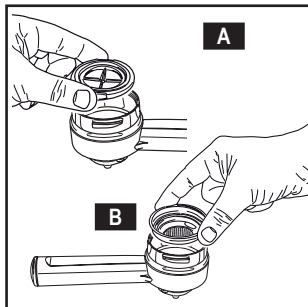

Fig.10 - Abb.10 - Afb.10 - Rys.10

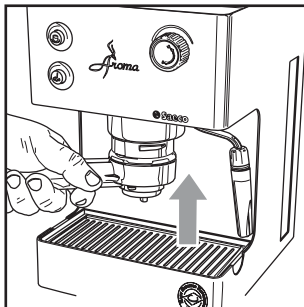

Fig.11 - Abb.11 - Afb.11 - Rys.11

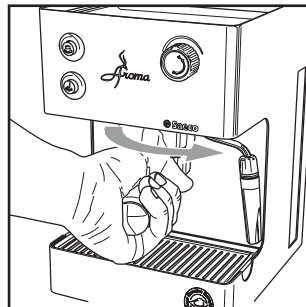

Fig.12 - Abb.12 - Afb.12 - Rys.11

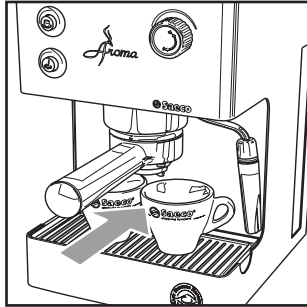

Fig.13 - Abb.13 - Afb.13 - Rys.13

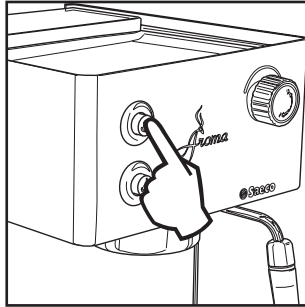

Fig.14 - Abb.14 - Afb.14 - Rys.14

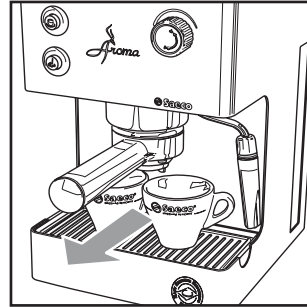

Fig.15 - Abb.15 - Afb.15 - Rys.15

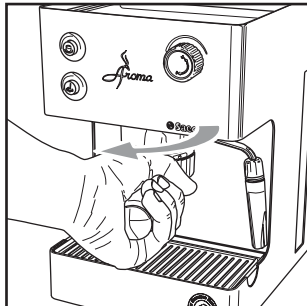

Fig.16 - Abb.16 - Afb.16 - Rys.16

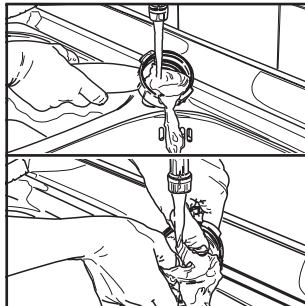

Fig.17 - Abb.17 - Afb.17 - Rys.17

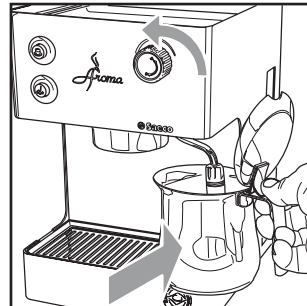

Fig.18 - Abb.18 - Afb.18 - Rys.18

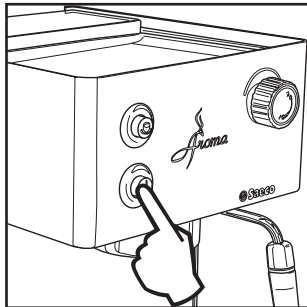

Fig.19 - Abb.19 - Afb.19 - Rys.19

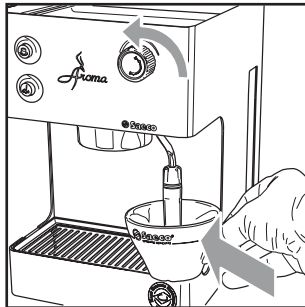

Fig.20 - Abb.20 - Afb.20 - Rys.20

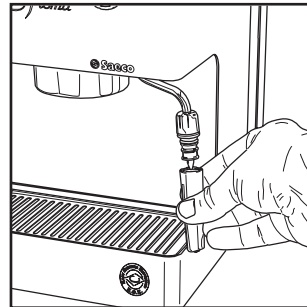

Fig.21 - Abb.21 - Afb.21 - Rys.21

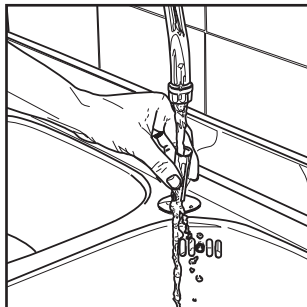

Fig.22 - Abb.22 - Afb.22 - Rys.22

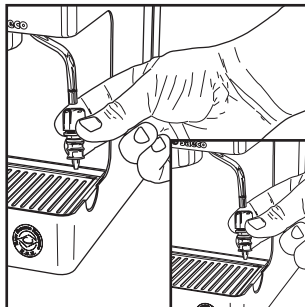

Fig.23 - Abb.23 - Afb.23 - Rys.23

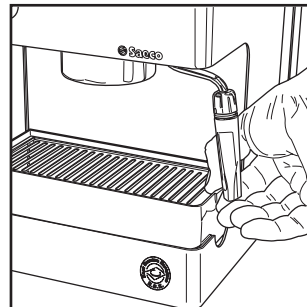

Fig.24 - Abb.24 - Afb.24 - Rys.24

## IMPORTANT SAFEGUARDS

When using electrical appliances, basic safety precautions should always be followed, including the following:

1. Read all instructions.
2. Do not touch hot surfaces. Use handles or knobs.
3. To protect against fire, electric shock and injury to persons do not immerse cord, plugs, or appliance in water or other liquid.
4. Close supervision is necessary when the appliance is used by or near children.
5. Unplug from outlet when not in use and before cleaning. Allow to cool before putting on or taking off parts, and before cleaning the appliance.
6. Do not operate any appliance with a damaged cord or plug or after the appliance malfunctions, or has been damaged in any manner. Return appliance to the nearest authorized service facility for examination, repair or adjustment.
7. The use of accessory attachments not recommended by the appliance manufacturer may result in fire, electric shock or injury to persons.
8. Do not use outdoors.
9. Do not let cord hang over edge of table or counter, or touch hot surfaces.
10. Do not place on or near a hot gas or electric burner, or in a heated oven.
11. Always attach plug to appliance first, then plug cord into wall outlet. To disconnect, turn any control to "off", then remove plug from wall outlet.
12. Do not use appliance for other than intended use.
13. Save these instructions.

English

## SAVE THESE INSTRUCTIONS



## INSTRUCTIONS FOR THE POWER SUPPLY CORD

- A A short power-supply cord is provided to reduce risks of tangling or tripping over a longer cord.
- B Longer extension cords are available and may be used if care is exercised in their use.
- C If a long extension cord is used:
  - 1 the marked electrical rating of the extension cord should be at least as great as the electrical rating of the appliance.
  - 2 if the appliance is of the grounded type, the extension cord should be a grounding type
  - 3 the cord should not hang from the table to avoid the risk of tangling or tripping.

## 1 GENERAL INFORMATION

This coffee machine is made for brewing 1 or 2 cups of espresso coffee and features a swivel steam and hot water spout. The controls on the front of the machine are labeled with easy-to-read symbols. The machine has been designed for domestic use only and is not suitable for professional continuous use.



**Warning. No liability is assumed for any damage caused by:**

- Incorrect use not in accordance with the intended purposes;
- Repairing not carried out by authorized service centers;
- Tampering with the power cord;
- Tampering with any parts of the machine;
- The use of non-original spare parts and accessories;
- Failure to descale the machine and storage at temperatures below 0°C/32°F.

In these cases, the warranty is not valid.

### 1.1 To facilitate reading



A warning triangle draws attention to all the instructions that are important for user's safety. Please carefully follow these instructions to avoid serious injury!

The reference to illustrations, parts of the appliance or controls, etc. is indicated by numbers or letters; in this case please refer to the illustration.



This symbol is used to highlight the information that is particularly important for ensuring optimal use of the machine.

### 1.2 How to use these operating instructions

Keep these operating instructions in a safe place and make them available to anyone else who may use the coffee machine.

For further information or in case of problems, please refer to an authorized service center.

## 2 TECHNICAL DATA

The manufacturer reserves the right to make changes to the technical specifications of the product.

Nominal Voltage - Power rating - Power supply	See label on the appliance
Housing	Metal
Size (w x h x d)	210 x 300 x 255 (mm) / 9 x 12 x 11 in
Weight	7.5 kg / 16.5 lbs
Cord length	1.2 m / 47 in
Control panel	Front
Portafilter	Pressurized portafilter
Pannarello	Plastic
Water tank (Removable)	2 liters / 68 oz.
Pump pressure	15 bar
Boiler	Stainless steel
Safety devices	Manual reset thermostat Thermofuse

## 3 SAFETY REGULATIONS



**Never place live parts in contact with water: Danger of short circuit! Steam and hot water may cause scalding! Do not direct the steam or hot water jet toward parts of the body; handle the steam/hot water spout with care: Danger of scalding!**

### Intended use

The coffee machine is intended for domestic use only. Do not make any technical changes or use the machine for unlawful purposes since this would create serious hazards! The appliance is not for use by persons (included children) with reduced physical, mental or sensory abilities or with scarce experience and/or competences, unless they are under supervision of a person in charge of their safety or they are informed by him/her on the use of the appliance.

### Power supply

Only connect the coffee machine to a suitable socket. The voltage must correspond to the indication on the machine's label.

### Power cord

Never use the coffee machine if the power cord is defective. If damaged, the power cord must be replaced by the manufacturer or its customer service department. Do not pass the cord around corners, over sharp edges or over hot objects and keep it away from oil. Do not use the power cord to carry or pull the coffee machine. Do not pull out the plug by pulling on the power cord or touch it with wet hands. Do not let the power cord hang freely from tables or shelves.

### Protecting others

Prevent children from playing with the appliance. Children are not aware of the risks linked to electrical appliances. Do not leave the coffee machine packaging within the reach of children.

### Danger of burns

Never direct the jet of hot steam and/or hot water towards yourself or others. Always use the handles or knobs provided.

Do not disconnect (remove) the Portafilter during coffee brewing. Hot water drops may spill out of the coffee brew unit during the warming phase.

### Location

Place the coffee machine in a safe place, where no one may overturn it or be injured.

Hot water or steam may spill out: **Danger of scalding!**

Do not keep the machine at a temperature below 0°C/32°F; freezing may damage the machine.

Do not use the coffee machine outdoors.

Do not place the machine on hot surfaces and close to open flames to prevent its housing from melting or being damaged.

### Machine Cleaning

Before cleaning the machine, deselect all buttons, then remove the plug from the socket.

Then wait for the machine to cool down. Never immerse the machine in water!

It is strictly forbidden to tamper with the inside of the machine. Any water left in the tank for several days should not be consumed. Wash the tank and fill it with fresh drinking water.

### Space for Operation and Maintenance

To ensure that the coffee machine works properly and efficiently, the following conditions are recommended:

- Choose a level surface;
- Select a location that is sufficiently well-lit, clean and near an easily reachable socket;
- Allow for a minimum distance from the sides of the machine as shown in **Fig. A**.

### Storing the Machine

If the machine is to remain out of use for a long time, turn it off and unplug it from the socket. Store it in a dry place out of reach of children. Shelter it from dust and dirt.

### Servicing / Maintenance

In case of failure, faults or a suspected fault after dropping, immediately remove the plug from the socket. Never attempt to operate a faulty machine. Servicing and repairing may only be carried out by authorized service centers. All liability for damages caused by service work not carried out in a professional manner is declined.

### Fire Safety

In case of fire, use Carbon Dioxide extinguishers (CO<sub>2</sub>). Do not use water or dry-powder extinguishers.

---

#### Key to machine components (Page 4)

---

- |    |  |
|----|--|
| 1  | Cup stacking surface                         |
| 2  | Control panel                                |
| 3  | Hot water/steam knob                         |
| 4  | Water tank cover                             |
| 5  | Water tank                                   |
| 6  | Drip tray & grill                            |
| 7  | Coffee Brew Unit                             |
| 8  | Steam spout (Pannarello)                     |
| 9  | Power cord                                   |
| 10 | Ground coffee measuring scoop                |
| 11 | Ground coffee filter<br>(for 1 or 2 coffees) |
| 12 | Pod filter                                   |
| 13 | Pod filter adapter                           |
| 14 | Portafilter                                  |
| 15 | Brew button                                  |
| 16 | Steam button                                 |
| 17 | ON/OFF button                                |

---

## 4 INSTALLATION

---

For your own and for other people's safety, carefully follow the "Safety Regulations" in section 3.

---

### 4.1 Packaging

---

The original packaging has been designed to protect the machine during transport. We recommend keeping the packaging for future transport.

---

### 4.2 Installation Instructions

---

Before installing the machine, read the following safety instructions carefully:

- Place the machine in a safe place;
- Make sure children cannot play with the machine;
- Do not place the machine on hot surfaces or near open flames.

The coffee machine is now ready to be connected to the power supply.

**i** **Note:** It is recommended that machine parts be washed before their first use and/or after they have not been used for a period of time.

#### 4.3 Machine Connection

**!** **Warning!** Electric power can be dangerous! It is therefore essential to follow the safety regulations carefully. Never use faulty cords! Faulty cords and plugs must be immediately replaced by authorized service centers.

Appliance voltage has been pre-set by the manufacturer. Check that the power voltage matches the indications on the identification plate located on the bottom of the appliance.

- Check that the ON/OFF button (17) is not pressed before connecting the machine to the power supply.
- The power cord is located inside the machine. Follow the instructions in section 4.4 to lift the water tank.  
(Fig.3) - Place the power cord correctly, so that it does not interfere with the water tank.
- Fit the plug into a wall socket with suitable power voltage.

#### 4.4 Water Tank

- (Fig.1) - Remove the cover from the water tank (4).
- (Fig.2) - Lift the suction pipe and remove the water tank (5); make sure not to damage the water suction pipe.
- (Fig.4) - Rinse the tank and fill it with fresh drinking water taking care not to overfill.
- (Fig.5) - Lift the suction pipe and fit the tank back into its housing.
- (Fig.6) - Correctly replace the water suction pipe into the tank; and place the cover back onto the tank.

**!** **Warning!** Only use fresh, non-sparkling drinking water to fill the tank. Warm or hot water, or any other liquid, may damage the tank. Do not turn on the machine with empty water tank: always make sure there is enough water in the tank.

#### 4.5 Priming the Water Circuit

Before starting up the machine, after long storage and when the water has been used up, be sure the machine's water circuit has been primed.

- (Fig.7) - Press the ON/OFF button (17).
- (Fig.8) - Place a container below the steam spout. Open the hot water/steam knob (3) by turning it counter-clockwise and press the brew button (15).
- Wait until a steady jet of water flows out of the steam spout (Pannarello).

- Push the brew button (15) and close the hot water/steam knob (3) by turning it clockwise. Remove the container.

The machine is now ready to brew coffee and dispense steam. Please see related sections for operating details.

### 5 COFFEE BREWING

**!** **Warning!** Do not remove the Portafilter by manually turning it clockwise, during the coffee brewing. Danger of burns.

- During this operation, the brew button (15) may flash on and off; this is to be considered as standard operation and not a fault.
- Before using the machine, make sure that the hot water/steam knob (3) is closed and that there is enough water in the tank.
- (Fig.7) - Press the ON/OFF button (17).
- Wait until the brew button light (15) turns on. The machine is now ready for coffee brewing.

#### 5.1 Using ground coffee

- (Fig. 9-A) - Insert the ground coffee filter (11) into the Portafilter (14).
- (Fig. 11) - Insert the Portafilter in the brew unit from the bottom (7).
- (Fig.12) - Turn the Portafilter from left to right until it locks in place. Release the grip from the Portafilter. The handle slightly turns to the left. This movement guarantees the perfect operation of the Portafilter.
- (Fig.14) - Preheat the Portafilter by pressing the brew button (15). Water will pour out of the Portafilter (this operation is only necessary for the first coffee).
- After a few ounces of water have flowed out, press the brew button (15) again to stop hot water dispensing.
- (Fig.16) - Remove the Portafilter from the machine by turning it to the left and pour out any water left. As the machine is fitted with the special Portafilter (14), there is no need to change the filter to make one or two coffees.
- (Fig.9-B) - Add 1 or 2 level measuring scoops of ground coffee to the filter for one or two coffees; clean any coffee residues from the edge of the Portafilter.
- (Fig.11) - Insert the Portafilter (14) in the brew unit from the bottom (7).
- (Fig.12) - Turn the Portafilter from left to right until it locks in place.
- (Fig.13) - Take 1 or 2 preheated cups and place them under the Portafilter; check that they are correctly placed under the coffee dispensing holes.
- (Fig. 14) - Press the brew button (15).
- When the desired quantity of coffee has been reached, press the brew button again (15) to stop the coffee brewing and remove the cups of coffee (Fig.15).
- (Fig.16) - Wait a few seconds after brewing, then remove the Portafilter and empty the remaining coffee grounds.

**i** Note for cleaning: Keep the filter of the Portafilter clean, by removing and washing it with drinking water after each use (Fig. 17).

---

## 5.2 Using Coffee Pods

---

- (Fig.9-A) - Remove the ground coffee filter (11) from the Portafilter (14) by pulling it out.
- (Fig.10) - Insert the coffee pod adapter (13) - with the curved part facing down - into the Portafilter (14); then insert the pod filter (12).
- (Fig.11) - Insert the Portafilter into the brew unit from the bottom (7).
- (Fig.12) - Turn the Portafilter from left to right until it locks in place.
- Release the grip from the Portafilter. The handle automatically turns slightly towards the left. This movement assures the perfect operation of the Portafilter.
- (Fig.14) - Preheat the Portafilter by pressing the brew button (15). Water will pour out of the Portafilter (this operation is only necessary for the first coffee).
- After a few ounces of water have flowed out, press the coffee button (15) again to stop hot water dispensing.
- (Fig.16) - Remove the Portafilter from the machine by turning it from right to left and emptying out the remaining water.
- Insert the pod in the Portafilter; make sure the paper from the pod does not hang over the edge of the Portafilter.
- (Fig.11) - Insert the Portafilter into the brew unit from the bottom (7).
- (Fig.12) - Turn the Portafilter from left to right until it locks in place.
- Take 1 preheated cup and place it under the Portafilter; check that it is correctly placed under the coffee dispensing holes.
- (Fig. 14) - Press the brew button (15).
- When the desired quantity of coffee has been reached, press the coffee button (15) again to stop coffee brewing and remove the cup of coffee.
- (Fig.16) - Wait a few seconds after brewing, then remove the Portafilter and dispose of the used pod.

**i** Note for cleaning: Keep the filter of the Portafilter clean by removing it and washing with drinking water after each use (Fig. 17).

---

## 6 TIPS FOR CHOOSING COFFEE

---

As a general rule any type of coffee available on the market can be used. However, coffee is a natural product and its flavor changes according to its origin and blend. Therefore it is a good idea to try different types, in order to find the most suited to your personal taste. For best results, we recommend using blends which are made especially for espresso coffee machines. Coffee should always be dispensed by the Portafilter without a "dripping" effect.

• 18 •

The speed of coffee dispensing can be modified by slightly changing the amount of coffee in the filter and/or using a different coffee grind.

**!** BEFORE USING THE HOT WATER/STEAM FUNCTION, MAKE SURE THAT THE STEAM SPOUT (PANNARELLO) IS POSITIONED OVER THE DRIP TRAY.

---

## 7 HOT WATER

---

**!** Danger of scalding! At the beginning, short spurts of hot water may come out. The brewing spout can reach high temperatures: do not touch it with bare hands.

- (Fig.7) - Press the ON/OFF button (17).
- Wait until the brew button light (15) turns on. The machine is now ready.
- During this operation, the brew button (15) may flash on and off; this is to be considered as standard operation and not a fault.
- (Fig.8) - Place a container or a glass under the steam spout (Pannarello). Open the knob (3) by turning it counter-clockwise and press the button (15).
- When the desired quantity of hot water has been dispensed, press the button (15) and close the knob (3) by turning it clockwise.
- Remove the container with hot water.

---

## 8 STEAM / CAPPUCCINO

---

**!** Danger of scalding! At the beginning, short spurts of hot water may come out. The brewing spout can reach high temperatures: do not touch it with bare hands.

- (Fig.7) - Press the ON/OFF button (17).
- Wait until the brew button (15) turns on.
- (Fig.19) - Press the steam button (16). The brew button light goes off (15).
- Wait until the steam button light (16) turns on. The machine is now ready for steam dispensing.
- During this operation, the steam button (16) light may flash on and off. This is to be considered as standard operation and not a fault.
- (Fig.18) - Insert a container below the steam spout and open the knob (3) for a few seconds, so that residual water flows out of the steam spout (Pannarello). Wait until there is a steady jet of steam.
- Close the knob (3) and remove the container.
- Fill a container 1/3 with cold milk.

**i** Use cold milk to get a better froth.

- (Fig.20) - Immerse the steam spout in the milk and open the knob (3) by turning it counter-clockwise. Turn the

milk container with slow upward movements so that it is warmed evenly.

- Once the container is filled with milk froth, close the knob (3), remove the cup with the frothed milk.
- (Fig.19) - Press the steam button (16) again.
- Proceed with circuit priming as described in section 4.5 to make the machine ready for use.

**i** **Note:** The machine is ready when the machine ready light (15) is permanently on.

**i** **Note:** If it is not possible to dispense steam as described, prime the circuit as explained in section 4.5 and then repeat the steps.

**i** The same process can be used to heat other beverages.

- After this operation, clean the steam spout with a wet cloth.

## 9 CLEANING

Maintenance and cleaning may only be carried out when the machine has cooled down and has been disconnected from the power supply.

- Do not immerse the machine in water or place any of its parts in a dishwasher.
- Do not use alcohol, solvents and/or aggressive chemical agents.
- We recommend cleaning the water tank and filling it up with fresh water daily.
- (Fig.21-22) - Every day, after heating the milk, remove the external part of the Pannarello and wash it with fresh drinking water.
- (Fig.23) - The steam spout should be cleaned weekly. In order to do this, you need to:
  - Remove the external part of the Pannarello (for standard cleaning);
  - Loosen the ring nut (without removing it);
  - Remove the upper part of the Pannarello from the steam spout;
  - Wash the upper part of the Pannarello with fresh drinking water;
  - Wash the steam spout with a wet cloth and remove any milk residue;
  - Replace the upper part of the steam spout (make sure it is completely inserted);
  - Tighten the previously loosened ring nut.
- Reassemble the external part of the Pannarello.
- (Fig.24) - Empty and clean the drip tray daily.
- Use a damp cloth to clean the appliance.
- (Fig.17) - To clean the Portafilter proceed as follows:
  - Remove the filter, wash it thoroughly with hot water.
  - Remove the adapter (if fitted), wash it thoroughly with hot water.
  - Wash the internal part of the Portafilter.
- Do not dry the machine and/or its components using a

microwave and/or conventional oven.

## 10 DESCALING CYCLE

The formation of limescale inside the appliance is inevitable. It is necessary to descale the machine every 3-4 months of use and/or when you notice a reduction in water flow.

**i** You can use a non-toxic and/or non-harmful descaling product for coffee machines (commercially available). We recommend using Saeco descaling solution.

**!** **Warning!** Do not use vinegar as a descaler.

- (Fig.2) - Remove and empty the water tank. Remove the Portafilter from the machine.
- (Fig.4) - Mix the descaling solution with water as instructed on the descaling product box and fill the water tank. Fit the tank into the machine.
- (Fig.7) - Turn on the machine by pressing the ON/OFF button (17).
- (Fig.8) - Place a container below the steam spout.
- Open the knob (3) and press the button (15) to dispense water at intervals (one cup at a time). Press the button (15) and close the knob (3) to stop dispensing.
- (Fig.7) - During each interval allow the descaling solution to settle for about 10-15 minutes by turning the machine off. Empty the container.
- (Fig.2; Fig.4) - Repeat this process, until the descaling solution is finished, remove the water tank, rinse it and fill it with fresh drinking water.
- (Fig.5; Fig.6) - Reinsert the tank in the machine.
- (Fig.8) - Open the knob (3) and press the button (15) to dispense 2/3 of the water. Press the button (15) and close the steam knob (3) clockwise to stop dispensing.
- Let the machine warm up and empty the water tank as described above.

**i** If you are using a product other than the recommended one it is important to always follow the manufacturer's instructions shown on the descaling box.

## 11 DISPOSAL

- Put unused appliances out of service.
- Disconnect the plug from the socket and cut the electrical cord.
- At the end of its life, take the appliance to a suitable waste collection site.

This product complies with EU Directive 2002/96/EC.



The symbol  on the product or on its packaging

indicates that this product may not be treated as household waste. Instead it shall be handed over to the applicable collection point for the recycling of electrical and electronic equipment.  
By ensuring this product is disposed of correctly, you will help prevent potential negative consequences for the

environment and human health, which could otherwise be caused by inappropriate waste handling of this product. For more detailed information about recycling of this product, please contact your local city office, your household waste disposal service or the shop where you purchased the product.

Problem	Possible cause	Solution
The machine does not turn on.	Machine not connected to the power supply.	Connect the machine to the power supply.
The pump is very noisy.	Water tank empty.	Refill with water. (section 4.4).
The coffee is too cold.	The machine ready light (15) was off when the button was pressed.	Wait until the machine ready light (15) turns on.
	The Portafilter was not preheated (section 5).	Preheat the Portafilter.
	Cold cups.	Preheat the cups with hot water.
Milk does not froth.	The milk is not suitable: powdered milk, low-fat milk.	Use whole milk.
It is not possible to prepare a cappuccino.	The Pannarello is dirty.	Clean the Pannarello as described in section 9.
	No steam in the boiler.	Prime the circuit (section 4.5) and repeat the operations described in section 8.
The coffee is dispensed too fast, the crema does not form.	Not enough coffee in the Portafilter.	Add coffee (section 5).
	Coffee grinds are too coarse.	Use a different blend (section 6).
	The pod is old or not suitable.	Use a different blend (section 6).
	Old or not suitable pod.	Change the pod.
Coffee is not dispensed or dispensed only in drips.	No water.	Refill with water. (section 4.4).
	The grind is too fine.	Use a different blend (section 6).
	Coffee has been tamped or pressed in the Portafilter.	Shake the ground coffee.
	Too much coffee in the Portafilter.	Reduce the quantity of coffee in the Portafilter.
	Knob (3) is open.	Close the knob (3).
Coffee drips from the edges.	The machine has limescale build-up	Descalcify the machine (section 10).
	The filter in the Portafilter is clogged.	Clean the filter (section 9).
	The pod is not suitable.	Change type of pod.
	The Portafilter is incorrectly inserted in the brew unit.	Insert the Portafilter correctly (section 5).
	Upper edge of the Portafilter is dirty.	Clean the rim of the Portafilter.
	Pod inserted incorrectly	Insert the pod correctly. Make sure it doesn't hang over the edge of the Portafilter.
	Too much coffee in the portafilter.	Reduce the quantity of coffee using the measuring scoop.

Please contact an authorized service center for any problems not covered in the above table or when the suggested solutions do not solve the problem. Saeco USA Customer Service (1-800-933-7876).

**EC DECLARATION OF CONFORMITY**  
EC 2006/95, EC 2004/118,  
EC 1992/31, EC 1993/68

We :

**Saeco International Group**  
**Via Torretta , 240**  
**40041 GAGGIO MONTANO (BO)**

English

declare under our responsibility that the product :

**COFFEE MAKER**  
Type : SIN 15XN

to which this declaration relates is in conformity with the following standards or other normative documents :

- Safety of household and electrical appliances - General requirements  
EN 60335-1(2002 ) + A1(2004) + A2(2006) + A11(2004) + A12(2006)
- Safety of household and electrical appliances - Part 2-15  
Particular requirements for appliances for heating liquids  
EN 60335-2-15(2002) + A1(2005)
- Household and similar electrical appliances - Electromagnetic fields - methods for evaluation and measurement  
EN 50366 (2003) + A1 (2006).
- Electromagnetic compatibility (EMC) - Requirements for household appliances , electric tools and similar apparatus -  
Part 1 Emission EN 55014-1 (2000) + A1 (2001) + A2 (2002).
- Electromagnetic compatibility (EMC)  
Part. 3<sup>A</sup> Limits - Section 2 : Limits for harmonic current emissions (equipment input current ≤ 16A for phase) -  
EN 61000-3-2 (2000)
- Electromagnetic compatibility (EMC)  
Part 3<sup>A</sup> : Limits - Section 3 : Limitation of voltage changes , voltage fluctuations and flicker in public low - voltage supply  
systems , for equipment with rated current ≤ 16 A for phase and not subject to conditional connection  
EN 61000-3-3 (1995) + A1 (2001)
- Electromagnetic compatibility - Requirements for household appliances , electric tools and similar apparatus - Part 2.  
Immunity - Product family standard EN 55014-2 (1997) + A1 (2001)

following the provisions of the Directives :  
EC 73/23, EC 89/336, EC 92/31, EC 93/68.

Gaggio Montano  
05/07/2006

R&D  
Ing. Andrea Castellani



Type Sin015XN

Cod. 15001167 Rev.00 15-06-07



Saeco International Group S.p.A. Via Torretta, 240 - 40041 Gaggio Montano  
Bologna - Italy - Tel. +39 0534.771.111 - Fax. +39 0534.31025  
<http://www.saeco.com>

